



Whitehaven®
Under-mount Apron Front Kitchen Sink
K-6487

Features

- 30-inch minimum base cabinet width.
- KOHLER cast iron.
- Acid-resistant enamel finish.
- Under-mount.
- Single bowl.
- No faucet holes.
- Offset drain basin slopes toward drain to minimize water from pooling.

Recommended Accessories

K-9000 P-Trap

Optional Accessories

K-6638 Sink Rack

K-8801 Sink Strainer



Codes/Standards

ASME A112.19.1/CSA B45.2

**KOHLER® Lifetime Limited Warranty
for Cast Iron Components**

See website for detailed warranty information.

Available Color/Finishes

Color tiles intended for reference only.

Color	Code	Description
	0	White
	FF	Sea Salt™
	96	Biscuit
	47	Almond
	FD	Cane Sugar™
	NY	Dune
	95	Ice™ Grey
	G9	Sandbar
	33	Mexican Sand™
	K4	Cashmere
	FT	Basalt
	58	Thunder™ Grey
	20	Suede
	KA	Black 'n Tan
	FP	Caviar
	7	Black Black™

USA/Canada: 1-800-4KOHLER (1-800-456-4537)

Kohler Co. reserves the right to make revisions without notice to product specifications.

For the most current Specification Sheet, go to www.kohler.com.

7-4-2015 07:00

THE BOLD LOOK
OF **KOHLER**®

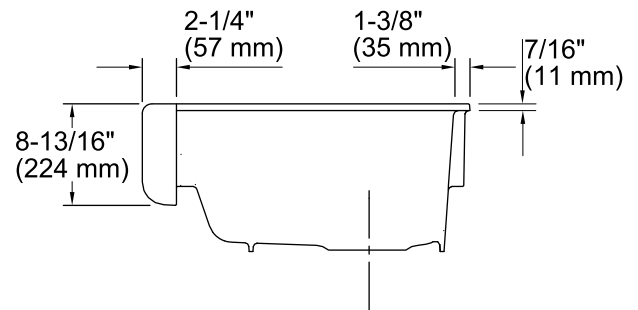
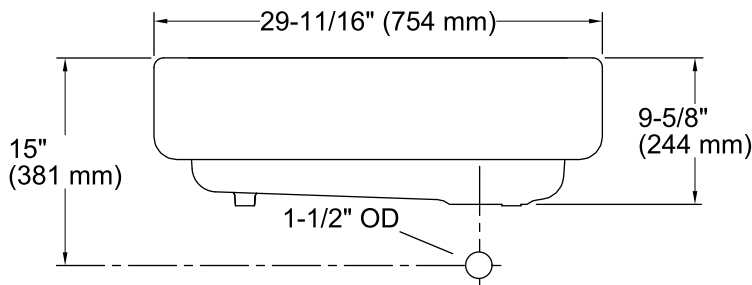
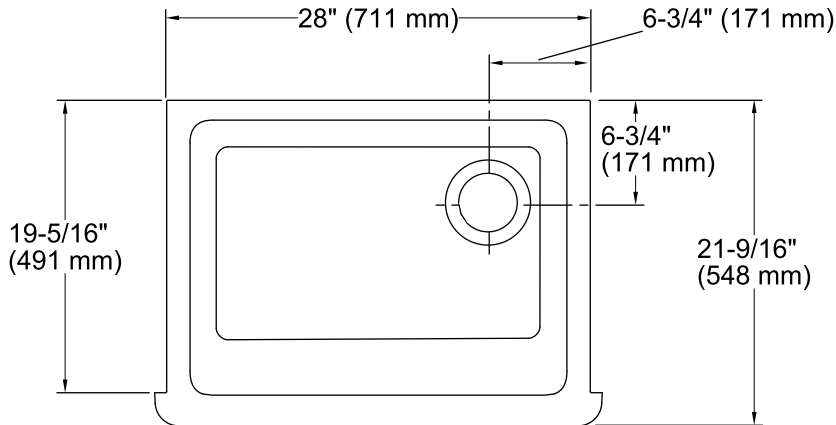

Technical Information

All product dimensions are nominal.

Bowl configuration:	Single
Installation:	Under-mount
Min. base cabinet width:	30" (762 mm)
Bowl area (Only)	Length: 24-3/4" (629 mm) Width: 18-1/16" (459 mm) Bowl depth: 9" (229 mm)
Drain hole:	3-5/8" (92 mm)
Template:	Under-mount, 1156909-7, required, included Apron Front, 1157000, required, included

Notes

Install this product according to the installation guide.

IMPORTANT! The distance from the top edge of the cabinet to the top of the cabinet door must be at least 9" (229 mm) to install this sink.

NOTICE: Countertop manufacturer or cutter must use the cutout template provided with the product, or a current one provided by Kohler Co. (call 1-800-4-KOHLER). Kohler Co. is not responsible for cutout errors when the incorrect cutout template is used.